

MAXIMUM[®]
digital technology

MR-2000
Enjoy the Music

**DIGITAL FM, INTERNET OG DAB RADIO
WITH AUDIO MEDIA STREAMING**

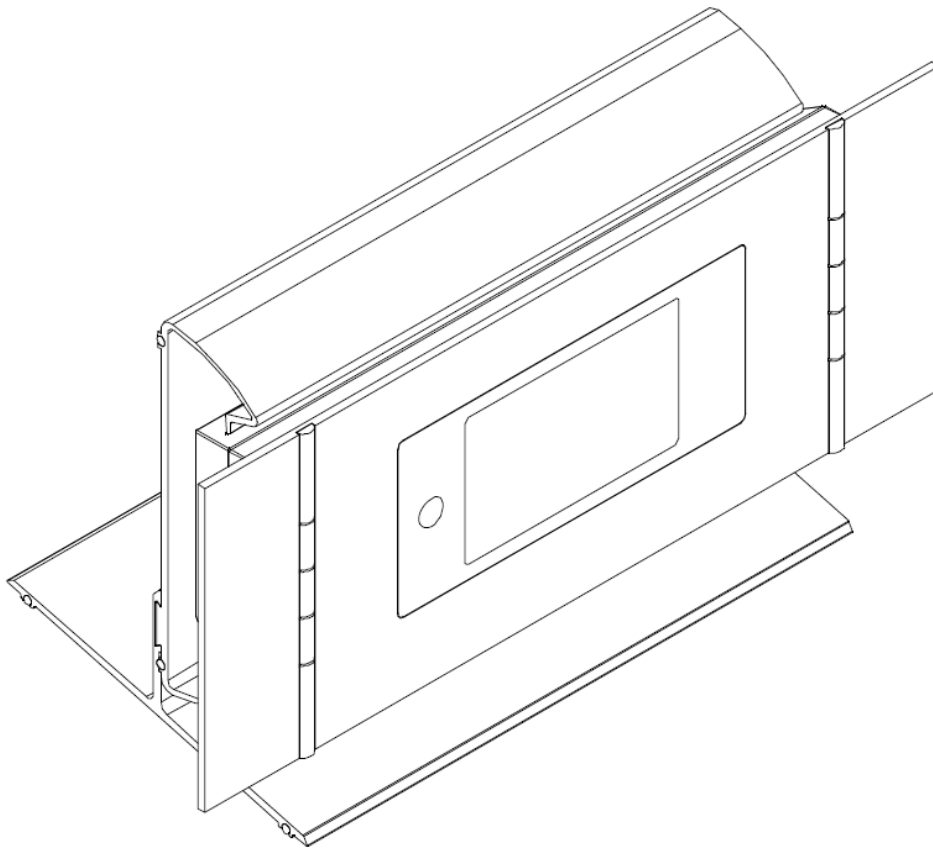

Instruction Manual

Safety Warnings

Please read before installation.

If MR-2000 has been moved from a cold place to a warm place, DO NOT plug it in for 2-3 hours (e.g. from a cold car boot to a warm room). There is a possibility that moisture may have condensed in the MR-2000 and this can cause damage to your MR-2000 if taken into use at once. To avoid damage please unpack your MR-2000 and allow it to stand in room temperature for 2-3 hours before use. This will cause moisture to evaporate and prevent unnecessary damage to your MR-2000.

DO ensure that the mains plug is easily accessible.

Covers - Do not remove any fixed covers as this may expose you to dangerous voltage.

Weather - It is advisable to unplug an external aerial during a thunderstorm.

Damage - Never use your MR-2000 if it is damaged in any way. Always place your MR-2000 on a flat level surface avoiding any surface which may be subject to strong vibration.

Temperature - Avoid extreme temperatures, either hot or cold. Place your MR-2000 well away from heat sources such as radiators or gas/electric ovens.

DO NOT use this product in tropical climates.





Moisture - Do not allow your MR-2000 to be exposed to rain, moisture or dust. If you spill any liquid onto your MR-2000 it can cause serious damage. In such case switch it off at the mains immediately. Contact your store without delay.

CAUTION - Do not open any covers and do not repair yourself. Qualified personnel must carry out repair work.

Contents

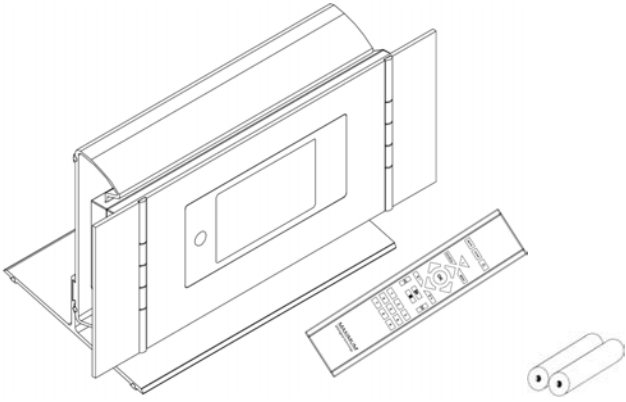
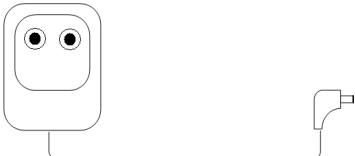
Package Content	3
MR-2000 - Quick Start Guide	4
What you need before you can use your MR-2000	4
Controls Overview (a)	5
Controls Overview (b)	6
Connecting to wired network.....	7
Step 1 - Power	7
Step 2 – Choose LAN Setting	7
Step 3 – Enter Internet Radio mode	7
Step 4 – Enter Network.....	8
Connecting to wireless network	8
Step 1 – Choose WLAN Setting	8
Step 2 – Select Your Region.....	8
Step 3 – Select Your Region.....	9
Step 4 – Enter Network.....	9
Choosing a station	12
Changing the Station Information	13
Station Updates.....	14
DAB Operation Mode	15
FM Operation Mode	16
Setting Station Presets	17
Selecting a Preset station	17
Music Player Operation Mode.....	18
Clock Settings	19
Daylight savings.....	20
System settings	20
Network setup	20
Language	21
Factory reset	21
Software Updates.....	22
SW Version and Radio ID	22
General Operation	23
Register	23
Requesting a Station.....	23
Returning To Main Menu	23
Volume.....	23
Appendix	24
Step 1: Set Up Media Sharing in Windows Media Player 11.....	24
Step 2: Play Music on the MR-2000.	25
Set Up Media Sharing in MAC OS.....	26
Troubleshooting	27
Specification	28

Package Content

<p>Main unit Remote control and batteries</p>	 <p>A line drawing showing the main unit of the digital radio, a remote control, and two AA batteries.</p>	
<p>AC/DC Adapter</p>	 <p>OUTPUT:6VDC 800mA</p> <p>A line drawing of an AC/DC adapter with a power cord and a DC output plug.</p>	
<p>Cable</p>	 <p>Audio cable</p> <p>A line drawing of an audio cable with two 3.5mm stereo connectors.</p>	 <p>Coaxial cable</p> <p>A line drawing of a coaxial cable with two RCA connectors.</p>
<p>User manual</p>	 <p>MAXIMUM digital technology DIGITAL RADIO WITH AUDIO MEDIA STREAMING Instruction Manual</p> <p>A line drawing of the user manual cover, featuring the product name and a small image of the main unit.</p>	

MR-2000 - Quick Start Guide

What you need before you can use your MR-2000

LAN Setting:

- Make sure the internet connection is ready and the network settings are available for LAN (ADSL or Cable Modems are highly recommended).
- To find the MR-2000's LAN MAC address, please follow this procedure:
Main menu → System setup → Internet setup → View settings → MAC Address

Wireless LAN Setting:

- A broadband Internet connection.
- A wireless access point (Wi-Fi) connected to your broadband Internet, preferably via a router.
- If your wireless network is configured to use Wired Equivalent Privacy (WEP) or Wi-Fi Protected Access (WPA) data encryption then you need to know the WEP or WPA code so you can get the MR-2000 to communicate with the network.
- If your wireless network is configured for trusted stations you will need to enter the MR-2000's MAC address into your wireless access point. To find the MR-2000's MAC address use menu items:
Main menu → System setup → Internet setup → View settings → MAC Address
- To enter the MAC address into your wireless access point, you must read the instructions supplied with the wireless access point.

Before you continue, make sure that your wireless access point is powered and connected to your broadband Internet, or that your LAN cable setting is OK. To get this part of the system working you must read the instructions supplied with the wireless access point and LAN connecting.

Controls Overview (a)

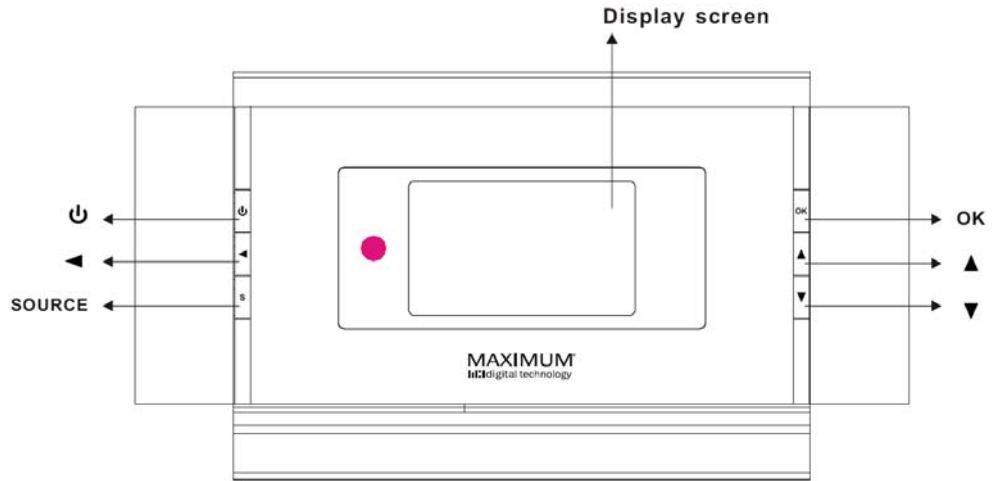

UNIT FRONT VIEW

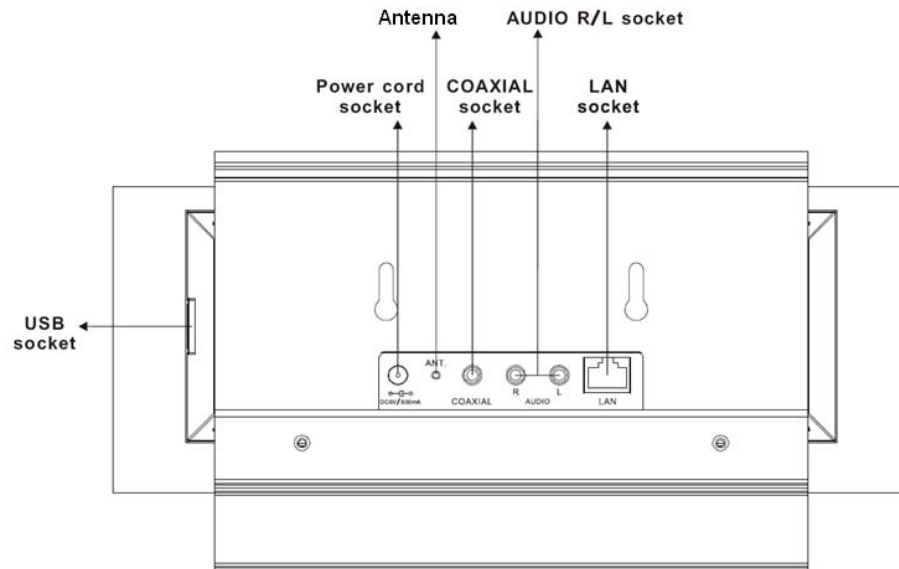

UNIT REAR VIEW

Control	Internet Radio	DAB,DAB+,FM mode	Media Player
	Press to turn the MR-2000 on/off		
	Go back to previous menu page		
	Press to change the source between Internet Radio, Music Player, DAB and FM		
	Press to confirm Press and hold to access menu FM mode, press to auto-seek stations		
	Press to move forward Press and hold to increase volume		
	Press to move downward Press and hold to decrease volume		

Controls Overview (b)

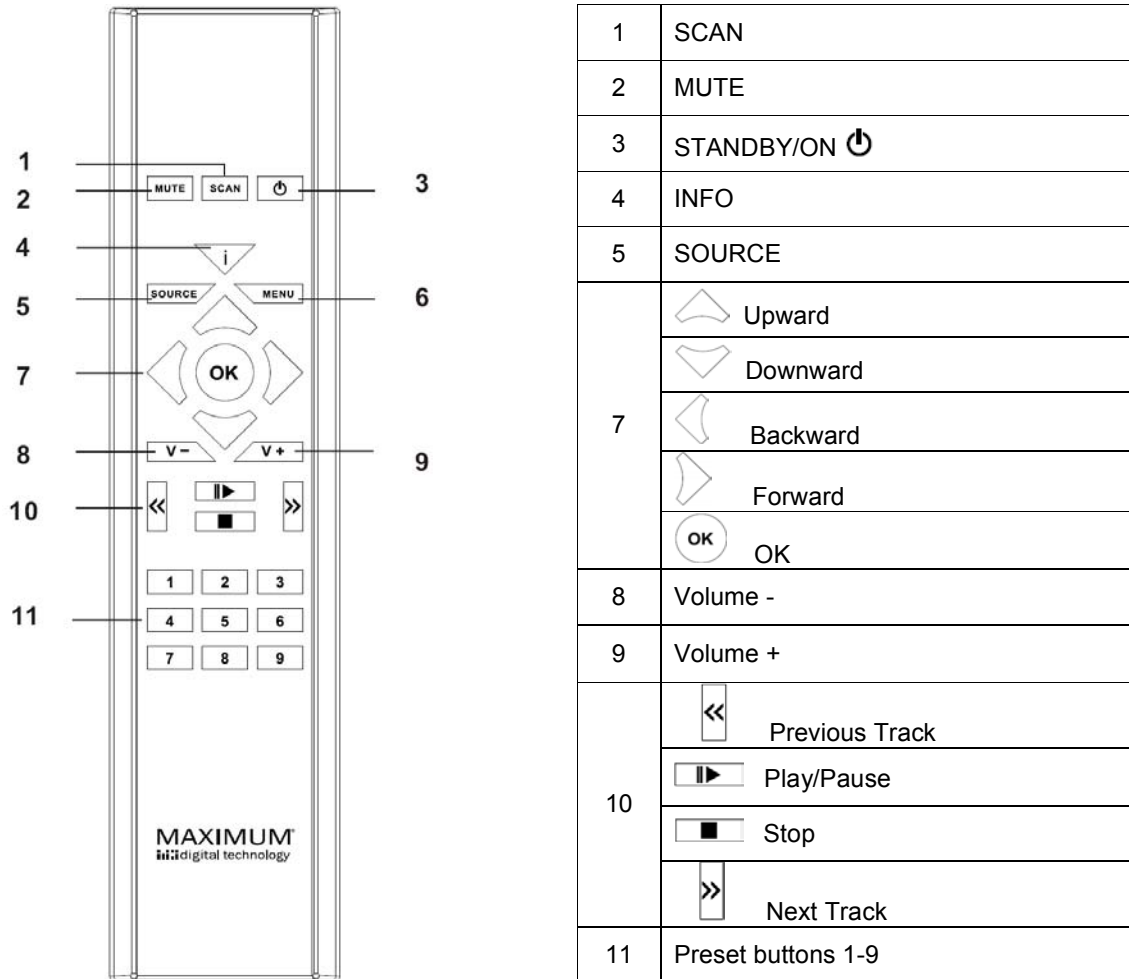

Note: item10, designed for Media player

Connecting to wired network

Step 1 - Power

First, connect an adaptor to your MR-2000 and ensure the Power LED light is on. Hereafter the MR-2000 can be switched on or off with the  button.

 **Note:** Make sure that LAN cable is connected.

Step 2 – Choose Wired Setting

1. Press **▲** or **▼** and select <SYSTEM SETTINGS>. Press **OK** to confirm, and then press **OK** again.

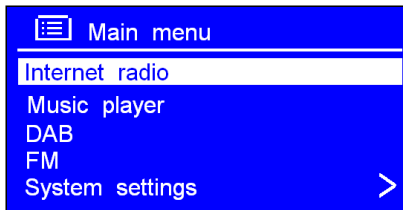

2. Press **▲** or **▼** and select <MANUAL SETTINGS >. Press **OK** to confirm and then press **OK** again.

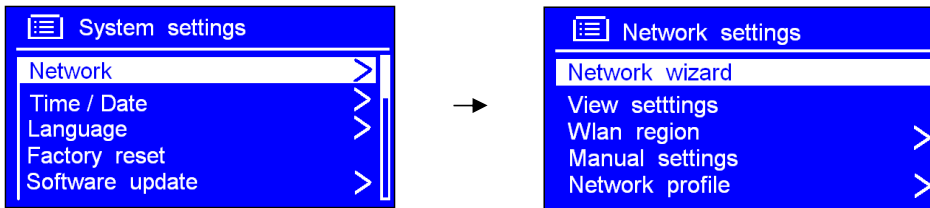

3. Press **▲** or **▼** and select <DHCP ENABLE >. Press **OK** to confirm.

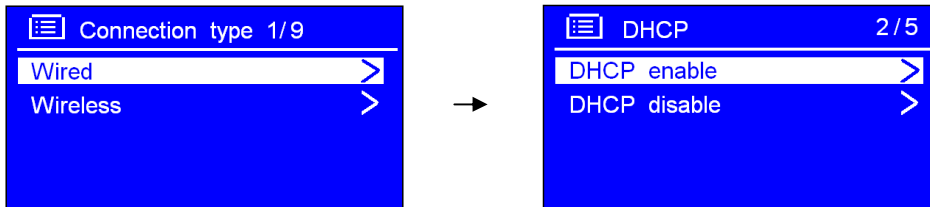

Step 3 – Enter Internet Radio mode

1. Press **◀** to go back to <MAIN MENU> subdirectory. Press **▲** or **▼** and select <INTERNET RADIO> and then press **OK** to confirm.

- Alternatively press **SOURCE** until <INTERNET RADIO> is shown.

Step 4 – Enter Network

Your MR-2000 will now connect to a Network automatically. After a few seconds, the following will appear on the screen:

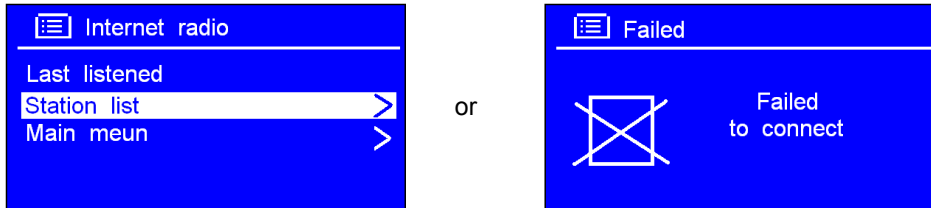

If '**Failed to connect**' message appears, please try the following:

- Check your router, see if it is working normally or not;
Check your LAN cable. Make sure it is not damaged, and that it is connected correctly.

Connecting to wireless network

Step 1 – Choose Wireless Setting

- Look up Step 2 “Choose Wired Setting” on page 6 . Press ▲ or ▼ and select <WIRELESS>, and then press **OK** to confirm.
- Press ▲ or ▼ and select <DHCP ENABLE>. Press **OK** to confirm.



Note: 1. you can also simply disconnect LAN cable from the LAN socket before connecting to the network.

2. You can, at any point, press ◀ to go back to the previous screen.

Step 2 – Select Your Region

- Press ◀ to go back to <MAIN MENU> subdirectory. Press ▲ or ▼ and select <INTERNET RADIO>, and then press **OK** to confirm.

Alternatively press **SOURCE** until <INTERNET RADIO> is shown.

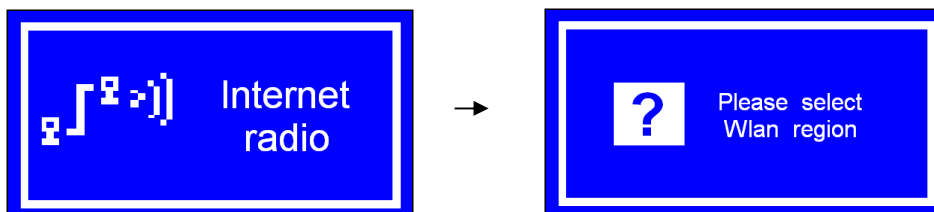

2. "Region choice" menu appears:



Step 3 – Select Your Network

1. Press ▲ or ▼ until your region is shown. Press **OK** to confirm and then your MR-2000 will ask you to enter your network.

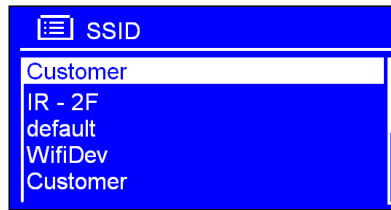
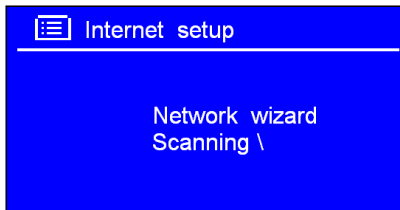

Step 4 – Enter Network

1. In some cases the MR-2000 may find more than one network. Press ▲ or ▼ to navigate through the name list, and then press **OK** when the name of your network is displayed.
2. If you do not need a password to enter your network (WEP/WPA), the MR-2000 will connect to the network and display:

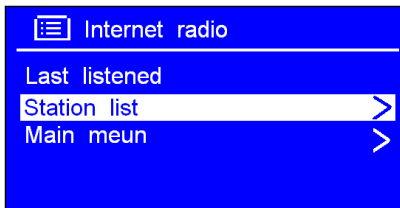

3. If a WEP/WPA password is required, the MR-2000 will now ask you to type the WEP/WPA code and will display the password entry screen:

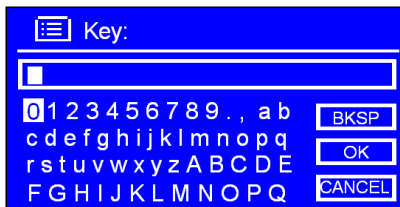

- a. Press ▲ or ▼ to navigate through the alpha-numeric character list. Press **OK** to select the appointed character.

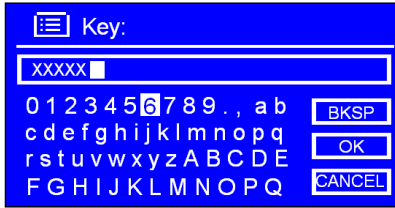

b. If you type a wrong character, select 'BKSP' icon to delete the character.

Note: a. to select BKSP, OK or CANCEL move the cursor to '0'. Press ▲ or ▼ to select the wanted character.
b. WEP/WPA password input is case-sensitive

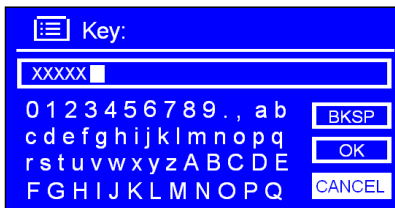

c. Select CANCEL to return to previous track.

d. After selecting the final character of your password, press ▲ or ▼ and press OK

4. You are now successfully connected to your network. Press ▲ or ▼ and select <STATION LIST>, and then press OK to confirm.

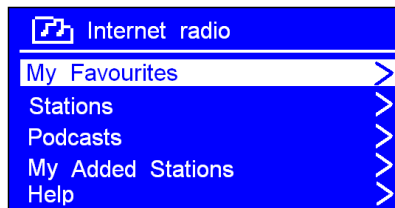
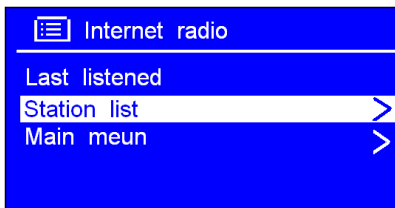

Note: a. MR-2000 will automatically remember the WEP/WPA you have selected.
b. You will not have to re-enter the password, unless a <FACTORY RESET> has been executed.

If MR-2000 fails to connect to the network:

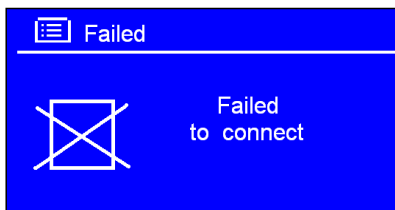

- A. Check if your router, is working properly or not;
- B. Try to find a more powerful signal for your MR-2000! Make sure you typed the correct password.

Note: You can at any point, press ◀ to go back to the previous screen.

5. To get your access code or **FAQ** solutions, press ▲ or ▼ and select <HELP>. Press **OK** to confirm.

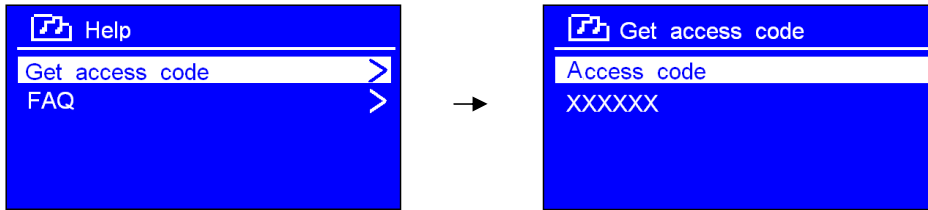

Choosing a station

After your MR-2000 has successfully connected to your network, you can now select a station.

1. Press ▲ or ▼ and select <STATION LIST> and press **OK** to confirm.

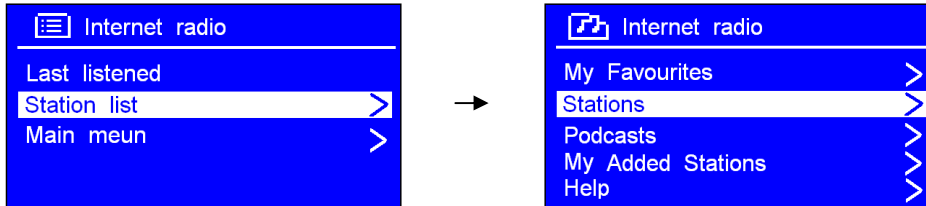

2. Press ▲ or ▼ and select <STATIONS> and press **OK** to confirm.

Note: 'LOCATION' enables you to choose a radio station provided by any country which you can choose from a list.

- a. Choose <LOCATION> and press **OK** to confirm.

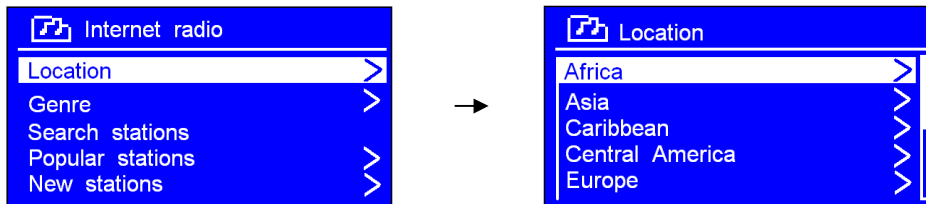

- b. Press ▲ or ▼ to choose your region and press **OK** to confirm. Using the same method chose a country and station. The MR-2000 will now load the information.

Note: 'GENRE' enables you to choose radio stations according to their content, for example Classic Rock, Sport, News, etc.

- a. Press ▲ or ▼ and select <GENRE> and press **OK**. Press ▲ or ▼ to choose the type of content you want and press **OK** to confirm.

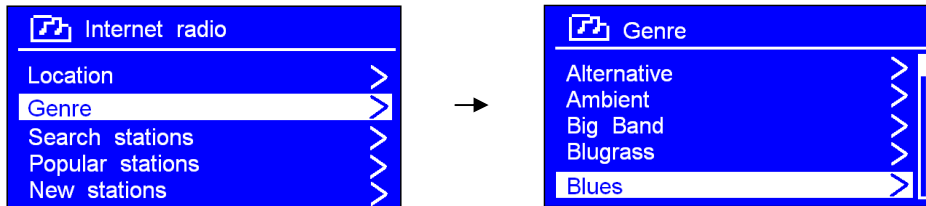

- b. Chose the station you want and press **OK** to confirm.

Note:

- a. some radio stations do not broadcast 24 hours a day, and some stations are not always available.
- b. some stations have on-demand content, that is, they give the option of listening to programs which have already been broadcasted.

Changing the Station Information

It is possible to change the information that is displayed on the second line of the display when listening to an Internet program. To change the information displayed press  button on the remote control.

1. Station Description

This is scrolling text information supplied by the Internet station. It may show music titles or details of the programme which are provided by the broadcaster.

2. Station Location

This is a description of the type of programme provided by either internet radio station or broadcaster.

3. Station Reliability

This will show the degree of station reliability which you are listening to.

4. Station Signal Information

This shows the digital bit rate and the signal mode.

5. Station Playback Buffer

This displays the playback buffer strength of current station.

6. Station Date

This displays the date.

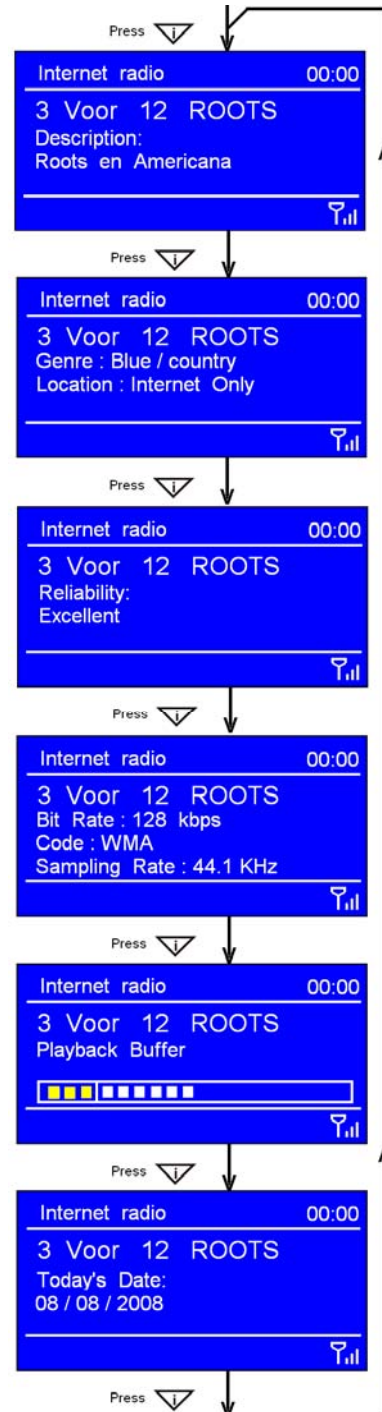

 **Note:** the difference between Wi-Fi and LAN program is visible on the bottom right corner, on the illustration below.

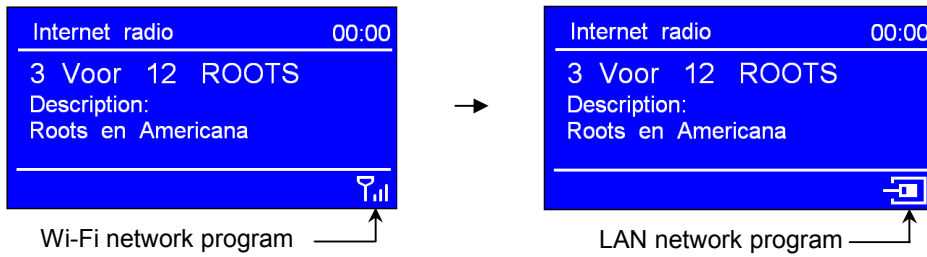



Station Updates

Automatic radio updates will occur periodically, ensuring that your MR-2000 is always updated.

DAB Operation Mode

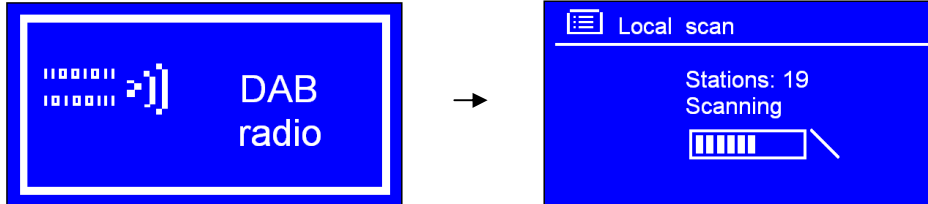
1. Switch the MR-2000 on and press **SOURCE** repeatedly until <DAB RADIO> appears. First time the MR-2000 is used it will automatically scan for DAB stations in your area and store them in memory.



 **Note:** to enter DAB mode, you may also press ◀ to go back to <MAIN MENU>, and then press ▲ or ▼ and select <DAB > and press **OK** to confirm.

2. Once the scanning is complete, the DAB stations will be displayed in alphanumeric order. The first station on the list will be selected.

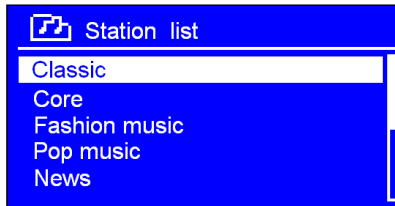



3. You can move back to the previous screen at any time by pressing ◀. <Local scan>, <Full scan> and <Manual tune> will then be available for your choice.
4. Once the scanning is completed, press ▲ or ▼ to cycle through stations list, and then press **OK** to confirm.

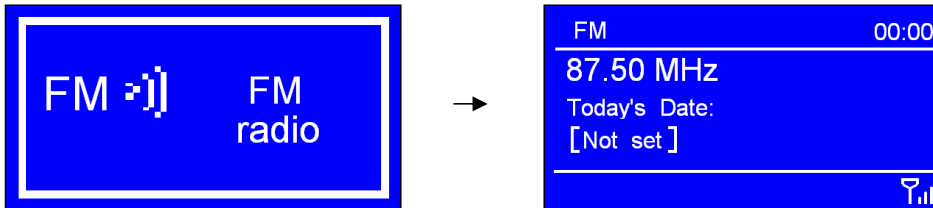

FM Operation Mode

A. GENERAL OPERATION

1. Switch the MR-2000 on and press **SOURCE** repeatedly until <FM RADIO> appears.



 **Note:** to enter the FM mode, you may also press ◀ to go back to <MAIN MENU>, and then press ▲ or ▼ and select <FM >. Press **OK** to confirm.

2. Press ▲ or ▼ to change the frequency.
3. To 'SEEK' active station automatically, press  or , then press  on the remote control. Alternatively simply press **OK**.

 **Note:** a. To 'seek' the next active station automatically, repeat step 3.

B. SCAN SETTING

1. When in FM mode, you can press ◀ and then press ▲ or ▼ and select <SCAN SETTING>. Press **OK** to confirm.

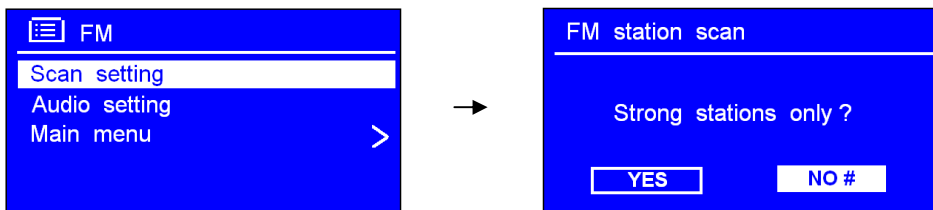

2. Press ▲ or ▼ to select 'YES' or 'NO', and then press **OK** to confirm.

C. AUDIO SETTING

1. When in FM mode, you can press ◀ and then press ▲ or ▼ and select <AUDIO SETTING>. Press **OK** to confirm.

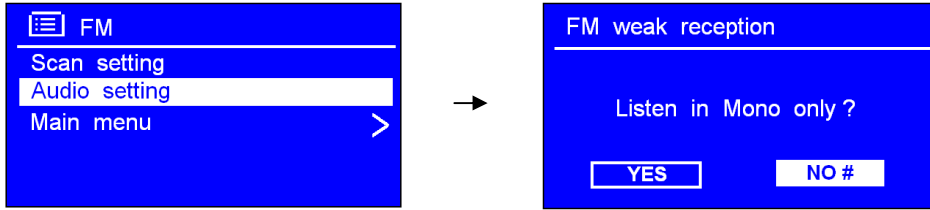

3. Press ▲ or ▼ to select 'YES' or 'NO', and then press **OK** to confirm.

Setting Station Presets

Your MR-2000 can store 9 Internet, 9 DAB and 9 FM station presets, to which you can memorize your stations:

1. Press and hold **PRESET** buttons 1-9 on remote control until the following appears:

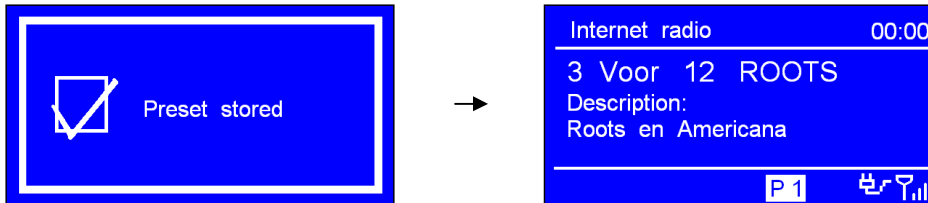

Selecting a Preset station

To select a stored Internet or FM station, enter corresponding mode, then simply press the corresponding preset button.

-  **Note:** do not hold the button down - if you do, the station currently playing will overwrite the one stored in the preset!

Music Player Operation Mode

A. PLAY SHARED MEDIA

1. Press **SOURCE** repeatedly until <MUSIC PLAYER> appears. Alternatively enter 'MAIN MENU' and then press ▲ or ▼ and select <MUSIC PLAYER>. Press **OK**.

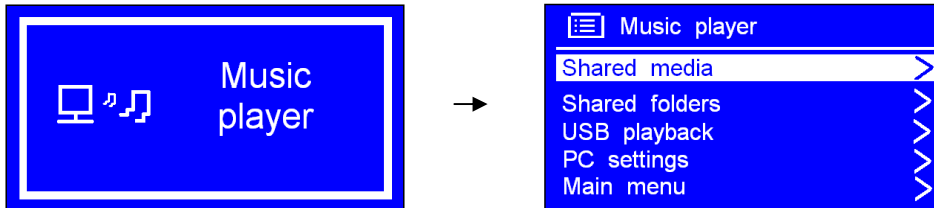

2. Press ▲ or ▼ and select one of the folders and choose your music.

B. PLAY SHARED FOLDERS

1. At <Music player> subdirectory, press ▲ or ▼ and select <SHARED FOLDERS>. Press **OK** to confirm.

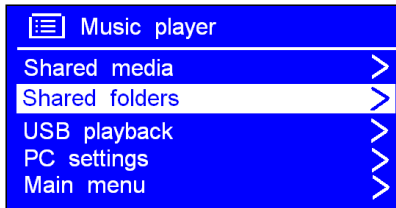

2. Press ▲ or ▼ and choose your music.

C. USB PLAYBACK

 **Note:** Regarding your USB device, make sure to backup your data on this device to ensure highest quality.

1. In <Music player> subdirectory, press ▲ or ▼ and select <USB PLAYBACK> and press **OK** to confirm.

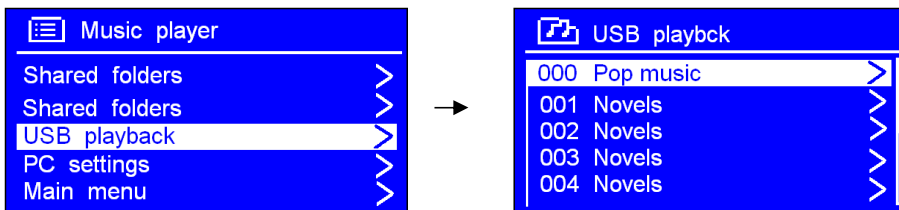

- 2 Press ▲ or ▼ and select the music stored on your USB.

Clock Settings

- At any point, you can enter <MAIN MENU> → <SYSTEM SETTINGS> → <TIME/DATE>. Press **OK**.

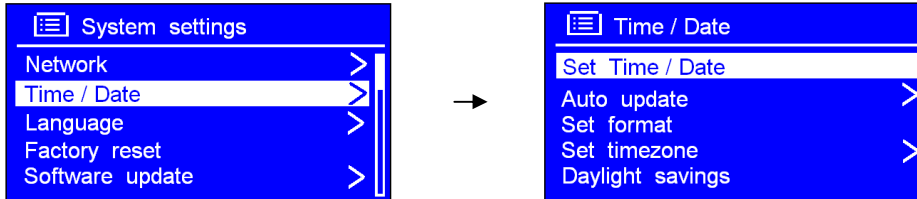

- Press **OK** to enter <Set Time/Date>, and then press ▲ or ▼ to set date. Press **OK** to confirm.

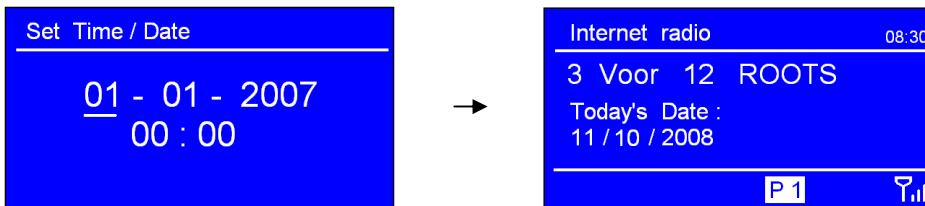

 **Note:** Use the same method to adjust month, year, hour and minute settings.

- At step 1, press ▲ or ▼ and select '**Auto update**' to perform auto time settings, or press ▲ or ▼ and select '**Set format**'. Press **OK** to confirm.

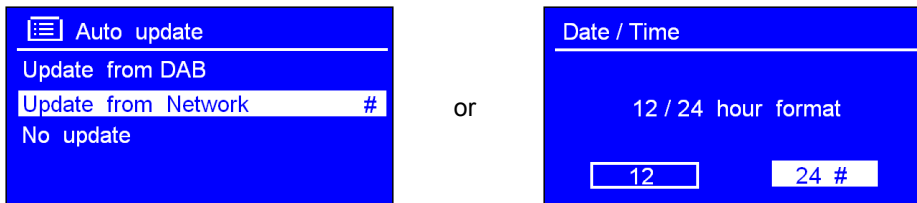

- At step 1, press ▲ or ▼ and select '**Set Timezone**'. Press **OK** to confirm.

- Press ▲ or ▼ to your location timezone and press **OK** to confirm.



Daylight savings

1. Daylight savings can be activated from <MAIN MENU> → <SYSTEM SETTINGS> → <TIME/DATE> → <DAYLIGHT SAVINGS>. Press **OK** to confirm, and then press ▲ or ▼ and select 'ON'.

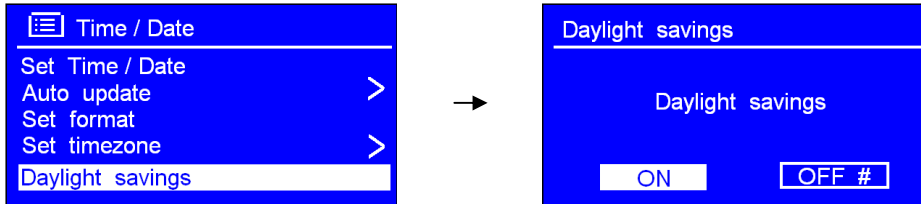

2. Press **OK** to confirm.

System settings

Network setup

 **Note:** Use this procedure if you want to connect the MR-2000 in another location. Following this procedure enables you to scan for connection to another wireless network, or to manually configure the network parameters.

1. Network setup can be activated from <MAIN MENU> → <SYSTEM SETTINGS> → <NETWORK>. Press **OK** to confirm.

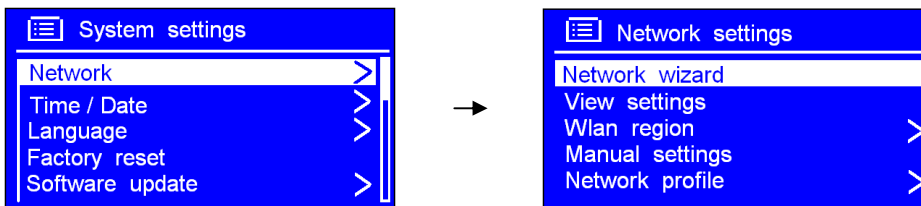

2. Press ▲ or ▼ and select the settings of your choice. Press **OK** to confirm.

Language

1. Language can be activated from <MAIN MENU> → <SYSTEM SETTINGS> → <LANGUAGE>. Press **OK** to confirm.

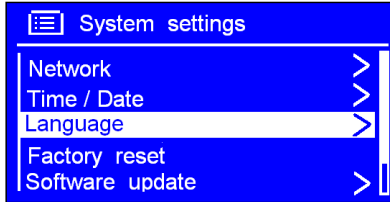

2. Enter System Settings and press ▲ or ▼ and select your language. Press **OK** to confirm.

Factory reset

 **Note:** Performing a factory reset will completely reset your MR-2000's memory, deleting all WEP/WPA codes and user settings. This will effectively reset the default factory settings.

1. Factory reset can be activated from <MAIN MENU> → <SYSTEM SETTINGS> → <FACTORY RESET>.

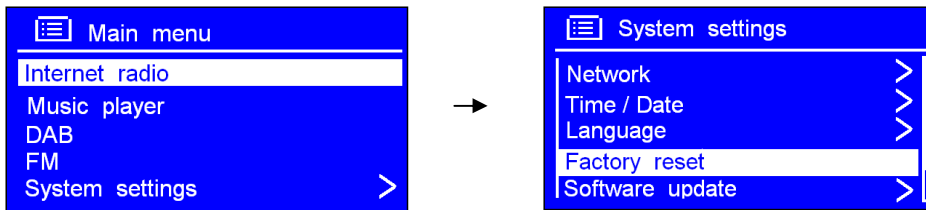

2. Press **OK** to confirm, and press ▲ or ▼ to select 'YES'.

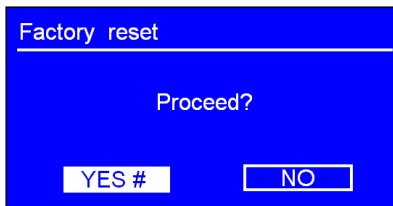

3. Press **OK** to confirm.

 **Note:** If you do not wish to continue, at step 3, press ▲ or ▼ to select 'NO', and then press **OK** to cancel this order. The MR-2000 will revert to its previous operating condition.

Software Updates

1. Software updates can be activated from <MAIN MENU> → <SYSTEM SETTINGS> → <SOFTWARE UPDATE>. Press **OK** to confirm and then press **▲** or **▼** and select 'Auto- check setting'.

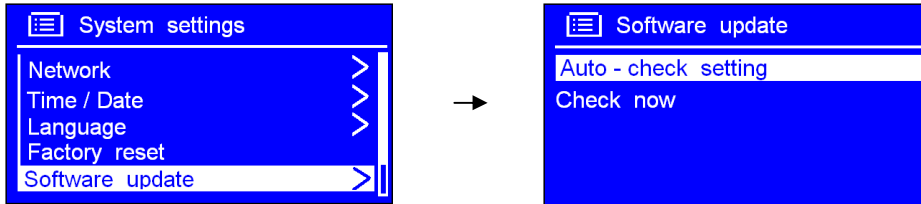

2. Press **OK** to confirm and then press **▲** or **▼** and choose 'YES'. Press **OK** to confirm, then press **▼** and select 'Check now'. Press **OK** to confirm.

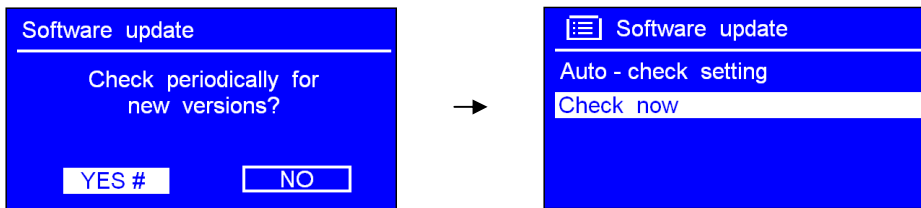

3. The MR-2000 display will display the following:

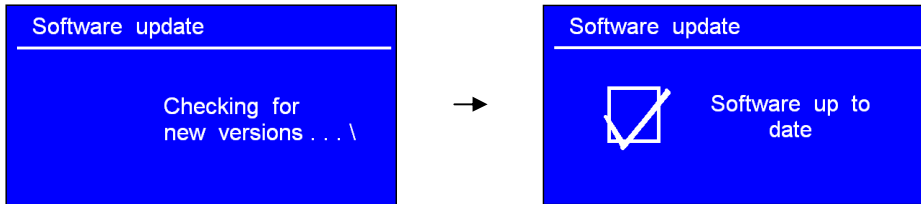

 **Note:** software update can take several minutes. To avoid permanent damage, do not switch the MR-2000 off until this procedure has been completed.

SW Version and Radio ID

1. Software version and Radio ID can be activated from <MAIN MENU> → <SYSTEM SETTINGS> → <INFO>. Press **OK** to confirm.

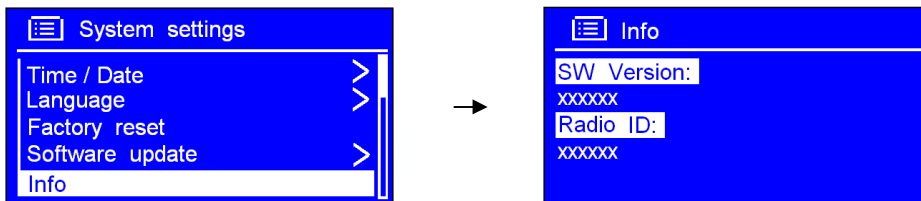

 **Note:** Software version and Radio ID information may be requested when dealing with technical support issues.

General Operation

Register

This will display a key code that can be used to register your MR-2000 on the Frontier customer portal:
<http://www.wifiRadio-frontier.com>



Requesting a Station

If you want to listen to a Radio station that is currently not listed in station list, you can visit the Frontier website at <http://www.wifiRadio-frontier.com> and make a request to add the station to the list.

Returning To Main Menu

- a. Simply press **MENU** on the remote control. Press ▲ or ▼ and select <MAIN MENU>.
- b. Alternatively, you can move back to MR-2000's top-line <MAIN MENU> at any time by pressing ◀.

Volume

To adjust the volume level, press  or  on the remote control. Alternatively, press and hold ▲ or ▼, and the MR-2000 will remember its previous volume level.

Appendix

Step 1: Set Up Media Sharing in Windows Media Player 11

After you have downloaded and installed Windows Media Player 11 for Windows XP, and connected your MR-2000 to the network, you need to set up media sharing so that you can share music with your MR-2000.

The following steps describe how to set up media sharing in Windows Media Player 11.

1. In Windows Media Player 11, click the small arrow below the **Library** tab, and then click **Media Sharing**.

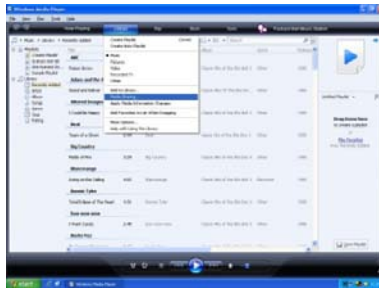

2. In the **Media Sharing** dialogue box, select the **Share my media** check box.

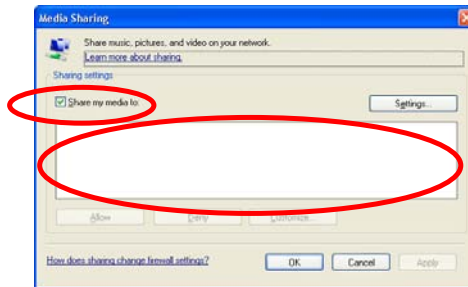

3. Check the “share my media to” box. In the list, click your **Radio ***, click **Allow**. The selected device will now show a green tick. Click **OK**.

* If your device does not appear in the list of devices, perform the following steps;

From the "Media Player" menu of your MR-2000 select "UPNP Servers"

A list of available computers will appear.

Select the required computer.

Your device will now appear in the list. If you want to check that this is your MR-2000, right click on the device and select “Properties”: your MR-2000's MAC address will be shown.



Step 2: Play Music on the MR-2000.

After installing and configuring your MR-2000 and Windows Media Player 11, you are now ready to play music via a wireless connection.

The following steps describe how to play music with your MR-2000.

1. Select "UPNP Servers" in the "Media Player" menu.
2. Select the computer you wish to play the music files from.
3. Use the controls to browse according to the following criteria: All Music, Genre, All Artists, Contributing Artists, Album Artists, Composers, Albums, Playlists, Folders or Star Ratings and then press **OK** to confirm.
4. Select the tracks you want to play, then press the Select button. Enjoy the music!

Set Up Media Sharing in MAC OS

Using the MR-2000 with a MAC will require Windows File Sharing. MAC OS 9 and earlier versions of the OS will need extra software to use Windows File Sharing, but MAC OS X 10.2 and later versions have Windows File Sharing built into the OS.

Set up Windows File Sharing on a MAC

- From the 'Dock', click on 'System Preferences'. From the 'System Preferences' window, under the 'Internet & Network' section, click on 'Sharing'.
- From the 'Sharing' window, do the following:
 - Under the 'Services' section, enable 'Personal File Sharing' and 'Windows Sharing'. In order to do this, tick the corresponding boxes or click on 'Start' for each of these services.
 - Under the 'Firewall' section, switch off the firewall.
 - Under the 'Internet' section, switch off 'Internet Sharing'.

Accounts Setup

- From the 'System Preferences' window, in the 'System' section, click on 'Accounts'. Select an account and remember its 'Short Name' and password. This will be used for the MR-2000 to connect to the MAC.

Directory Setup

- From the 'Dock', click on 'Finder'. From 'Finder', click on 'Applications then 'Utilities'. Click on 'More Info' for 'Directory Access' and ensure that the 'Read/Write' option is enabled. Double-click on 'Directory Access' and enable the following:
 - AppleTalk
 - LDAPv3
 - SLP
 - SMB/CIFS
- For 'SMB/CIFS', click on 'Configure' and select an appropriate workgroup.
- Copy and paste the mp3 files to 'Documents' in the 'Finder' window.
- Turn on 'AirPort' (wireless sharing).
- Wait for a few minutes.

In the 'Media Player' > 'Windows Shares' menu, enter the MAC account's short name and password. The MR-2000 should then be able to connect to the MAC.

Troubleshooting

If you experience any trouble with your wireless connection, then you may find it useful to visit the help section on our [webpage: http://www.wifiRadio-frontier.com](http://www.wifiRadio-frontier.com)

If you have trouble connecting the MR-2000 to your wireless network, these steps may help to resolve the problem:

1. Confirm that a Wi-Fi connected PC can access the Internet (i.e. can browse the web) using the same network.
2. Check that a DHCP server is available, or that you have configured a static IP address on the MR-2000. You can configure a static IP address on the MR-2000 using the menu item 'System setup → Network → Manual setting → Wireless', and then select 'DHCP disable'.
3. Check that your access point does not restrict connections to particular MAC addresses. You can view the MR-2000's MAC address using the menu item 'System setup → Network → View setting → MAC address'.
4. If you have an encrypted network, check that you have entered the correct key or password into the MR-2000. Remember that text-format keys are case sensitive. If your MR-2000 displays: 'Wireless error' followed by a 5-digit number, when attempting to connect to an encrypted network, then please ensure that you enter the correct passphrase for the network. If the problem persists, then you may need to consult your network configuration.
5. If your MR-2000 can connect to the network successfully, but is unable to play particular stations, it may be due to one of the following causes:
 - a. The station is not broadcasting at this time of the day (remember it may be located in a different time zone).
 - b. The station has reached the maximum number of allowed simultaneous listeners.
 - c. The station is not broadcasting anymore.
 - d. The link on the MR-2000 is out of date.
 - e. The Internet connection between the server (often located in a different country) and you is slow.

Try using a PC to play back the stream via the broadcaster's web site.

6. If you can play back the station with a PC, use the form at <http://www.wifiRadio-frontier.com> to notify us so that we can change the station data that is used by the MR-2000.

Specification

ITEMS	DESCRIPTION
Specifications:	Digital Radio, With Audio Media Streaming
Power Requirements:	AC Power Input: 100-240VAC, 50-60HZ for use, please refer rear panel silk-screen
Frequency Range:	(FM) 87.5-108MHz (DAB, DAB+) 174 – 240MHz
Ethernet socket:	RJ45
Line out socket:	47K ohm
Dimension:	210 x 120 x 150mm

Tips regarding environmental protection



At the end of its operating life, this product may not be disposed of by way of your normal household waste. Instead it must be delivered to a collection point for recycling electrical and electronic equipment. The icon on the product, in the operating instructions or on the packaging, indicates this.

The materials used in manufacturing this product are recyclable, depending on their identifying markings. By recycling this equipment, by recycling its components, or through other procedures of re-using outdated equipment, you are making an important contribution to protection our environment. Please ask you local municipal administration for the location of the corresponding recycling point.

